

EN Operating manual

High-pressure cleaner

K 1050 TS
K 1050 TST



Operating manual

EN

High-pressure cleaner

K 1050 TS
K 1050 TST

Operating manual!

This manual is a translation of the original manual. Read and conform safety instructions before use! Technical data will be found in the Spare parts list. Please be aware that the spare part list is part of the operating manual. Keep both leaflets for later use or any subsequent owners.

Dear customer:

We would like to congratulate you on the purchase of your new high-pressure cleaner and thank you for your confidence in our products!

Your choice has fallen on an absolute quality product! Kränzle high-pressure cleaners are characterized by their convenient and compact design as well as their high suitability for everyday use.

Highest precision and dimensional accuracy in addition to a technology package consisting of a multitude of details mark the difference when it comes to performance, safety and durability.

In order to facilitate handling of the high-pressure cleaner, the following pages are intended to further explain its use. The illustrations may be subject to deviation depending on the type of equipment or accessory of high-pressure cleaner purchased by you.

Contents	4
Explanatory symbols	5
Safety notes	6
General rules	9
Description of high-pressure cleaner	10
Functional details	14
Putting into operation	18
Taking out of operation	22
Small repairs - do it yourself	23
EU Declaration of Conformity	27
Kränzle accessories	28
Warranty	30

Explanatory symbols used in the operating manual



Failure to observe this note may entail environmental damage.



Note on the use of the high-pressure cleaner that failure to adhere to the instructions may cause excessive wear or total breakdown of the K 1050 TS/TST.



Warning!
Failure to observe this note may result in serious injuries!

Explanatory symbols affixed to the high-pressure cleaner



The high-pressure cleaner must be operated in horizontal position! In case of improper use, the high-pressure jets can be very dangerous. Do not direct high-pressure jet at persons, animals or active electrical equipment or the high-pressure cleaner itself.



The high-pressure cleaner may not be connected directly to the public drinking water supply network.



Risk of burns due to hot surfaces!



Products marked with this symbol may contain constituents posing a risk to health or the environment if incorrectly disposed of. These products must never be disposed of as household waste.

Explanatory symbols affixed on the packaging



This symbol denotes recyclable packaging materials which must not be disposed of as household waste. Information on proper disposal will be gathered from the recycling directives issued by your local authority.

User operating the high-pressure cleaner should wear the necessary protective clothing, i.e. waterproof clothing, rubber boots, safety goggles, ear protection headwear etc. It is prohibited to use the high-pressure cleaner in close vicinity to people lacking suitable protective clothing.

Use of high-pressure cleaners may result in aerosols being generated. An aerosol is a mixture of floating solid or liquid particles in a gas. Inhaling aerosol particles may cause damage to health. The emission of aqueous aerosols can be noticeably reduced if using fully shielded spray nozzles (as for instance on the floor-scrubber/round cleaner). If the use of fully shielded spray nozzles is not possible, a respiratory mask should be worn, Class FFP 2 or higher (depending on the environment due to be cleaned).

Whenever the high-pressure cleaner is left unattended, the mains disconnect switch must always be switched off.

Do not spray against matter containing asbestos or other hazardous substances!

Never spray flammable liquids or liquids containing solvents such as paint thinners, petrol, oil or similar liquids! Explosion hazard due to spraying such materials!

Due to the high-pressure jet, damage may occur on the objects to be cleaned, e.g. car tires; therefore, a minimum distance of 30 cm is to be kept!

Prior to putting the high-pressure cleaners into operation, check its components (High-pressure hose, power supply cables, safety trigger gun) for any damage. Replace defect or damaged components!

Only use high-pressure hoses, couplings and fittings recommended by Kränzle. Only these accessories ensure safety of the equipment.

If use is made of an extension cable, this must be suitable for outdoor use. In addition care needs to be taken to ensure that the cable is kept dry and that it is situated above the ground. We recommend the use of a cable drum capable of keeping the socket at least 60 mm above the ground.

Replacement of the power supply cables is only permitted by use of an original power supply cable of the manufacturer and must be performed by a qualified electrician.

Safety devices serve to protect the user and must never be de-activated or their function bypassed.

The high-pressure cleaner is to be properly used. The user is required to adhere to local requirements and to watch out for the persons in the danger zone!

If used in elevated positions where there is a risk of the unit falling to the ground, it must be secured against rolling away or tipping over.

The high-pressure cleaner is not designed for use by persons with restricted physical, sensory or mental abilities (including children)!

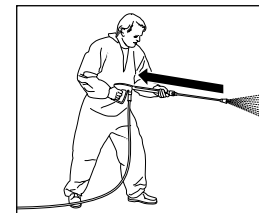

When using high-pressure water for cleaning, make sure that there is a clearly noticeable recoil effect on the lance. Therefore ensure a firm footing (see technical data).

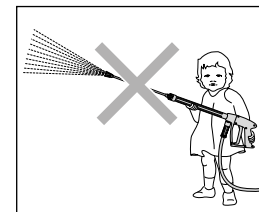

Never allow children or untrained persons to use the high-pressure cleaner or to play with it! Children must be kept under supervision to prevent them from playing with the equipment.

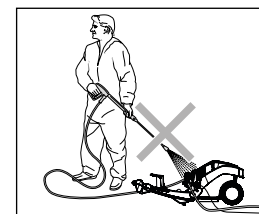

Never direct the high-pressure jet at the high-pressure cleaner itself! The high-pressure cleaner may not be placed within reach of the high-pressure jet spray mist!

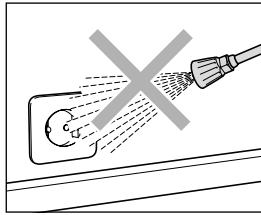

Never direct the high-pressure jet at power sockets or any other electrical installations! Within the working area, all live parts are to be protected from both water jet and spray mist.

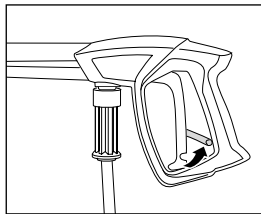

Apply the safety catch on the safety trigger gun after each use in order to prevent unintentional spraying!

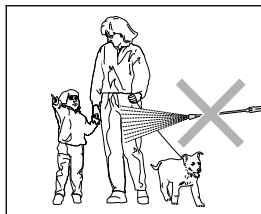

Never direct the high-pressure jet at people or animals! Never direct the high-pressure jet at yourself or other persons, not even to clean clothing or shoes.

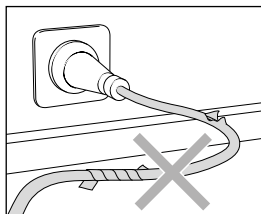

Only use a power supply cable in perfect working order! Do not damage or improperly repair the power cable (tearing, squeezing, running over, ...).

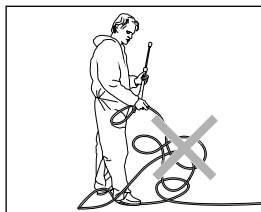

Never pull the high-pressure hose if it has formed kinks or "nooses"! Never pull the high-pressure hose over sharp edges!

Intended use

This high-pressure cleaner is to be used solely for high-pressure water jet cleaning applications without detergents or low-pressure cleaning work with detergents (e.g. with a foam injector or washing brush). It is solely designed for home users for typical applications around the house and garden (for cleaning façades, patios, garden equipment, tools, vehicles and machinery as well as building structures). It is not intended for commercial use.



Environmental, refuse disposal and water protection regulations must be observed!

Inspections

Whenever necessary and at least once every 12 months, the high-pressure cleaner needs to be inspected by a qualified expert to ensure that it is still safe to operate.

Accident prevention

The high-pressure cleaner is designed for accidents to be impossible if used correctly. The user is to be notified of the risk of injury from hot machine parts and the high-pressure jet. The "Guidelines for Liquid Spray Devices" must be complied with.



Oil leakage

If oil leaks contact your nearest after-sales service (dealer) at once. Failure to observe this instruction may cause damage to the environment and/or transmission gearbox.

Design: K 1050 TS (hose support with 8 m high-pressure hose)

The K 1050 TS cleaner is a mobile high-pressure cleaner with an advanced arrangement system. Please see construction scheme for more details.

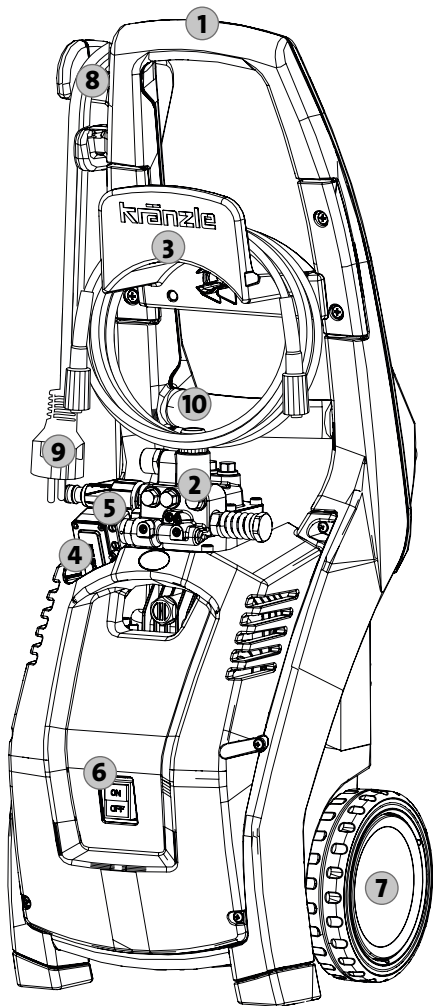

- 1 Ergonomically shaped handle
- 2 Pump head made of special brass
- 3 Hose support with 8 m high-pressure hose
- 4 Start/Stop switch
- 5 Supply water inlet sieve with filter
- 6 On/Off switch
- 7 Large stair climbing wheels
- 8 Cable reel for the power supply cable
- 9 Power supply cable with mains plug
- 10 Pump outlet / high-pressure hose connection

This is what you have purchased

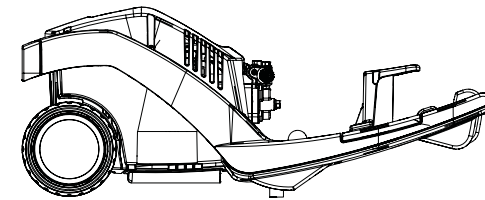

1. Kärnzle high-pressure cleaner K 1050 TS

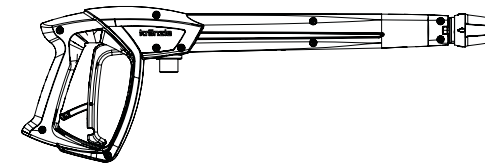

2. Safety trigger gun with insulated handle and plug coupling



3. Filth killer lance with stainless steel pipe and plugin nipple

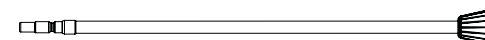

4. Flat jet nozzle with stainless steel pipe and plugin nipple

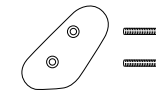

5. Crank handle with two fastening screws for the power supply cable



6. Operating manual
Spare parts list

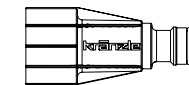

7. Water inlet sieve, plug coupling with visible filter

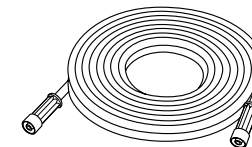

8. High-pressure hose

Design: K 1050 TST (with hose drum)

The K 1050 TST cleaner is a mobile high-pressure cleaner with an advanced arrangement system. Please see construction scheme for more details.

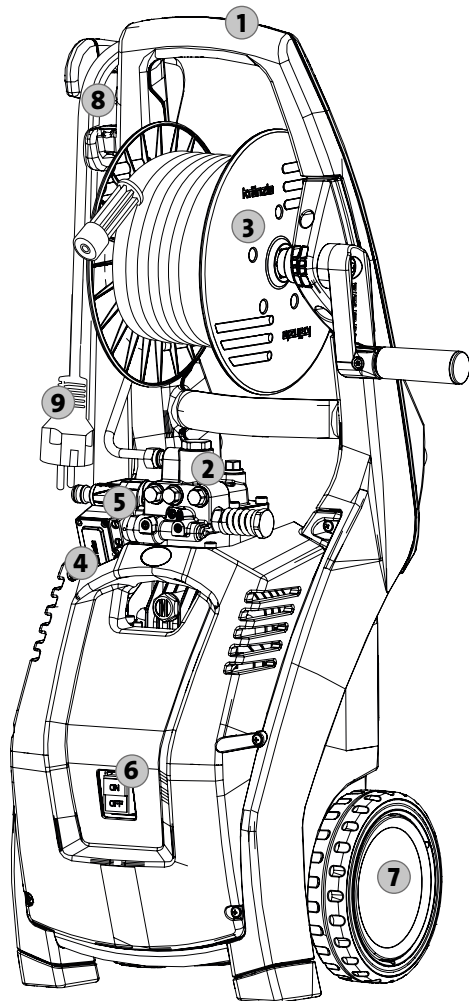

- 1 Ergonomically shaped handle
- 2 Pump head made of special brass
- 3 Hose drum with 12 m steel weave high-pressure hose
- 4 Start/Stop switch
- 5 Supply water inlet sieve with filter
- 6 On/Off switch
- 7 Large stair climbing wheels
- 8 Cable reel for the power supply cable
- 9 Power supply cable with mains plug

This is what you have purchased

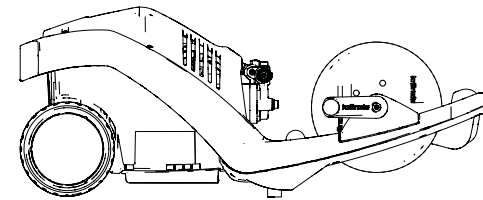

- 1. Kränzle high-pressure cleaner K 1050 TST

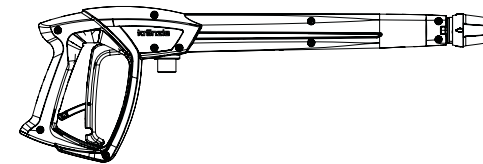

- 2. Safety trigger gun with insulated handle and plug coupling



- 3. Filth killer lance with stainless steel pipe and plugin nipple

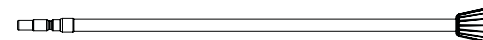

- 4. Flat jet nozzle with stainless steel pipe and plugin nipple

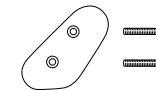

- 5. Crank handle with two fastening screws for the power supply cable



- 6. Operating manual
Spare parts list

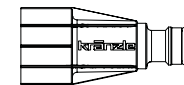

- 7. Water inlet sieve, plug coupling with visible filter

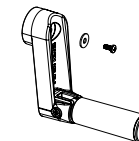

- 8. Crank handle with fastening screw

Please note: Lack of water

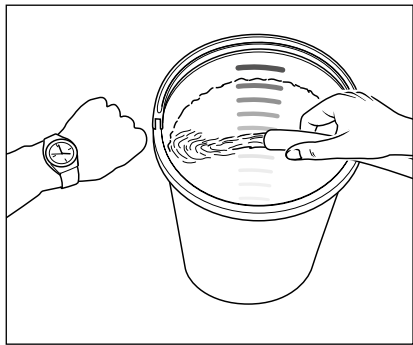

Lack of water occurs more often than you probably believe. The more powerful a high-pressure cleaner is the greater is the danger that a lack of water occurs. If there is only an insufficient amount of water available, cavitation (water-gas mixture) arises inside the high-pressure pump, which is normally noticed too late or even not at all. **The high-pressure pump will be destroyed.** Please check the available quantity of water by filling a bucket with liter scale for one minute.

Required minimum quantity of water (see technical data).



If the metered quantity of water is too small, you have to use a different water connection, guaranteeing the necessary output. Lack of water leads to an accelerated wear of the joints (no warranty).



Never let the high-pressure pump run dry for more than 60 seconds.

Water supply



Please pay attention to the regulations of your waterworks company! In accordance with DIN EN 61770, the high-pressure cleaner may not be directly connected to the public drinking water supply lines. A brief connection however is permissible according to DVGW (German Association for Gas and Water Affairs) if a non-return valve with tube ventilator (Kränzle item no.: 410164) is built into the water supply. **Once the water has passed through the non-return valve it is no longer considered as drinking water.** Also indirect connection to the public drinking water supply lines is permissible by way of free emission in accordance with EN 61 770; e.g. by using a reservoir with a float valve. Direct connection to a non-drinking water supply line is permissible.

Insufficient quantity of electricity

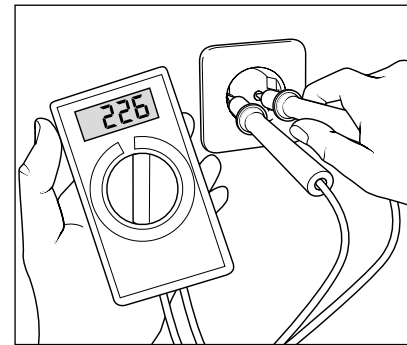

If there are too many collectors in your proximity connected to the network at the same time, the available voltage and the current intensity may decline. Consequently the motor of the high-pressure cleaner does not start or even blows. The power supply may also be insufficient if the power supply cable is too long or too thin. If extension cables are too long, this may lead to a voltage drop causing malfunctions or start-up difficulties.



Check the line fusing and have the voltage and the available current intensity checked by an expert in case of uncertainty (see technical data).

Electrical connection

The high-pressure cleaner is supplied with a 5 meters long power supply cable. The mains plug must be fitted to a standard grounded socket with a **30 mA** residual current operated device. Connection up to the mains must be carried out by a properly trained electrician and must comply with the requirements of IEC60364-1. The socket must be protected with a **16 A** fuse on the mains side. When using an extension cable, **this must have an earthed lead** which is properly connected to the socket. The conductors in the extension cable must have a minimum cross section of **1.5 mm²**. Plug connections must be of a spray-proof design, and may not be located on a wet floor. For extension cables of more than **10 m** in length, the minimum cross-section must be **2.5 mm²**! When using a cable drum, the power supply cable always must be unwound all the way.

Water and cleaning system

Water can be connected at mains pressure to the high-pressure pump. The water is then forced under pressure by the high-pressure pump to the lance. The high-pressure jet is formed by the nozzle at the end of the lance.



Environmental, refuse disposal and water protection regulations must be observed!

Safety jet pipe with safety trigger gun

The high-pressure cleaner can only be operated when the trigger of the safety deactivation trigger gun's trigger is actuated. When the trigger is pulled, the safety trigger gun opens. The liquid is then transported to the nozzle. The spray pressure increases and quickly reaches the operating pressure. When the trigger is released, the safety trigger gun closes and any further spraying of liquid from the safety jet pipe is prevented. The pressure thrust serves to close the start/stop system, thus interrupting the energy supply to the motor. Operating the safety trigger gun causes the start/stop system to open, the motor is automatically activated and the high-pressure pump starts to transport the water to the nozzle, where the high-pressure jet is produced.



The safety trigger gun is a safety device. Repairs should only be performed by qualified persons. Should replacement parts be required, use only components authorized by the manufacturer.



Replacements, repairs, new adjustments and sealing should only be performed by qualified persons.



Prior to putting the high-pressure cleaner into operation make sure that all safety instructions be observed.

Motor overload protection

Motor is protected against overload by means of a motor protection switch. In case of motor overload or blocking, the motor of the high-pressure cleaner switches off automatically. If motor tends to switch off repeatedly, make sure to detect and remedy the cause of the failure.



Replacements and inspection work should only be performed by qualified persons **when the high-pressure cleaner is disconnected from the power supply**, i.e. with plug pulled out from the electrical socket.

Totalstop system

The K 1050-series features a totalstop system. If the main switch is switched on, the motor is started via a pressure switch when opening the safety trigger gun. When closing the safety trigger gun the motor is switched off immediately.

High-pressure hose and spray device

The high-pressure hose and spray device which are part of the K 1050-series equipment, are made of high quality material and engineered to conform with the operating conditions of the high-pressure cleaner and are duly labeled.



If replacement parts are required, only such parts that are authorized by the manufacturer may be used. The warranty is automatically void if spare parts of third-party providers are used! The high-pressure hose and spray device must be connected in a pressure-tight manner (without leakage).



The high-pressure hose may not be driven over, pulled excessively, or twisted. The high-pressure hose may under no circumstances be pulled over sharp edges. Defective high-pressure hoses must not be repaired (acc. to DIN 20022) but have to be replaced by new hoses approved by the manufacturer.

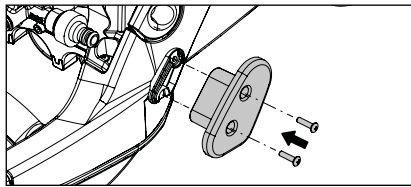

1. Use the supplied screws to fasten the lower cable retractor of the power supply cable in the place provided on the frame.

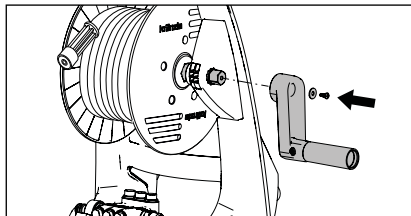

2. For high-pressure cleaners with hose drum the enclosed hand crank must be applied prior to first operation. Please set up the high-pressure cleaner. Plug the hand crank on to the hexagon and attach it with the enclosed screw and washer.

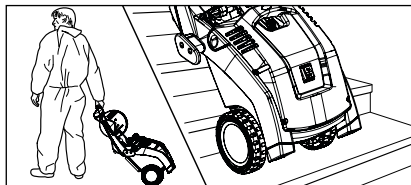

3. Move high-pressure cleaner to the job site. The K 1050 TS/TST is a movable high-pressure cleaner with sturdy trolleys ideally suited for difficult terrain and stairs.

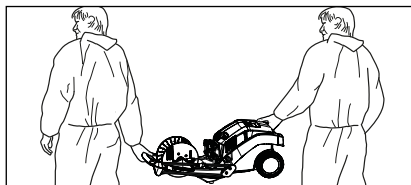

4. Owing to its light weight and handy size, the K 1050 TS/TST can be easily carried by two persons.



When carrying the K 1050 TS/TST, make sure to bear in mind the weight of the high-pressure cleaner (see technical data).



The high-pressure cleaner must be operated in horizontal position!



Neither set up or operate the K 1050 TS/TST in rooms where there is a risk of fire or explosion nor put it into puddles. Do not use the high-pressure cleaner under water. If, none the less, the high-pressure cleaner is operated in a hazardous area, the applicable safety regulations are to be observed.

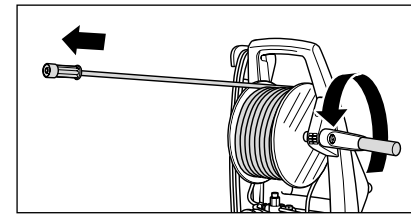

5. For high-pressure cleaners with hose drum, however, it must be uncoiled completely. For high-pressure cleaners without hose drum the high-pressure hose included in the scope of the delivery must be screwed with the pump outlet in a tight and pressure tight manner. Unwind high-pressure hose straight and without nooses. The high-pressure hose may leave signs of abrasion on some floors. Alternatively, please also find non-marking high-pressure hoses in our range.

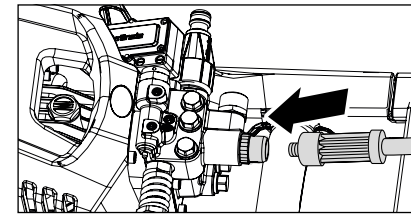

6. Tightly screw together high-pressure hose and safety trigger gun.

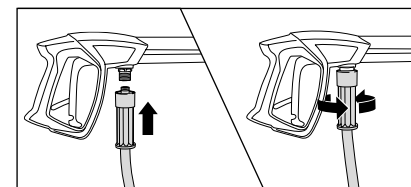

7. First pull back the retaining sleeve of the safety trigger gun, then insert lance into the plug coupling connection of the safety trigger gun.

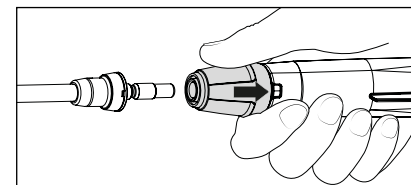

8. After insertion of the lance, release retaining sleeve and make sure that the lance is in a secure position. **Grease quick release nipple regularly using acid-free grease.**

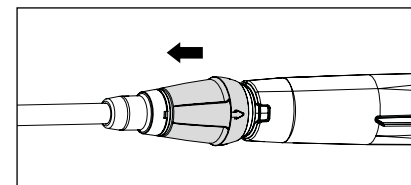

The plug coupling must not be actuated/handled during operation! High risk of injury!



Prior to insertion, check plug coupling connection of lance for cleanliness (sand, dirt ..) and use clear water to clean, if necessary. Impurities may damage the sealing in the plug coupling.



When using high-pressure hose extensions take care that the max. length of 20 m is not exceeded!



Accessories may only be connected to a Kränzle-approved trigger gun with safety catch.

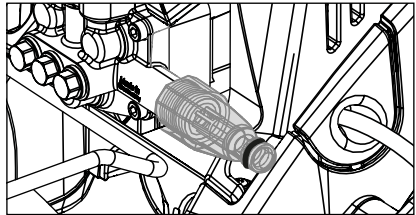

9. Check water inlet filter for cleanliness prior to putting the high-pressure cleaner into operation.

When inside filter is contaminated, remove filter and follow step 9.1. If the sieve is dirty, water cannot get through and pressure will not build up.

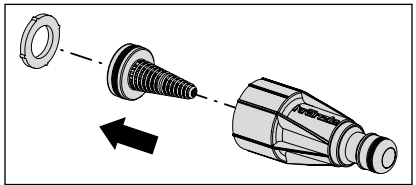

9.1 If contaminated, remove the filter and thoroughly rinse it with clear water and clean it with the other parts.



Check the water inlet sieve for damage. Do not operate the high-pressure cleaner without or with a damaged filter.

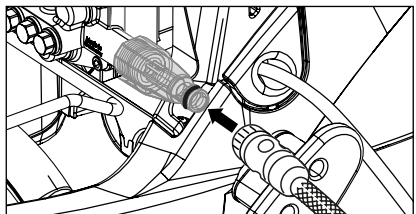

10. Connect the water hose to water inlet sieve (minimum requirements; 5 m hose length, cross-section 3/4", 10 bar). The high-pressure cleaner may be connected to a water mains (1-10 bar pre-pressure) with either cold or hot water (up to 60 °C).



Be careful when using hot water!

When running your high-pressure cleaner with hot water of 60 °C raised temperatures occur. Do not touch the metal parts of the high-pressure cleaner without safety gloves!

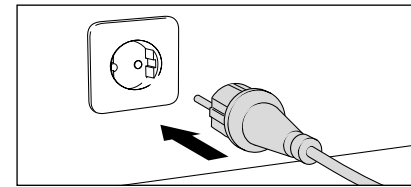

11. Connect to circuit (see technical data).



Do not touch the mains plug or any live parts with wet or moist hands.

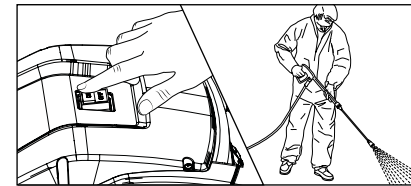

12. Switch on high-pressure cleaner with opened safety trigger gun. Bleeding of the high-pressure cleaner: Pull and release trigger of safety trigger gun several times. Start cleaning task.

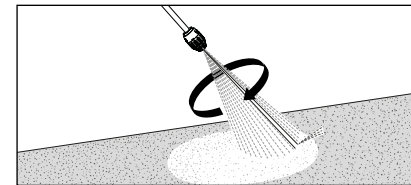

13. When using the filth killer lance make sure that lance points downward when starting.

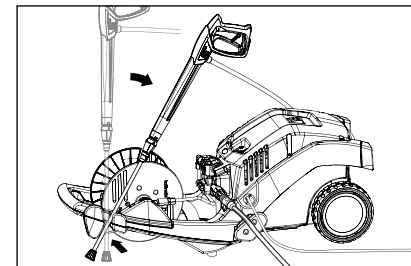

14. The K 1050 TS/TST units are equipped with a support for the safety trigger gun with lance during breaks.

The high-pressure cleaner must be operated in horizontal position!



It is imperative that safety instructions be observed during use of the high-pressure cleaner.

1. Switch off the high-pressure cleaner
2. Cut off the water supply
3. Open the safety trigger gun catch briefly until the pressure is released
4. Apply safety catch on the trigger gun
5. Remove high-pressure hose and safety trigger gun
6. Emptying high-pressure pump: Hold high-pressure hose and switch motor on until water jet stops escaping at the outlet.
7. Pull the plug from the socket
8. Clean high-pressure hose and wind up without loops
9. Clean and wind up the power supply cable
10. Clean the water inlet sieve
11. Store high-pressure cleaners in frost-free rooms in winter

Frost protection

For protecting the high-pressure cleaner against frost please empty it completely. Separate high-pressure cleaner from water supply and switch it on. By opening the trigger gun the high-pressure pump presses water out of the high-pressure cleaner. **However, do not allow the device to operate without water for more than one minute.**

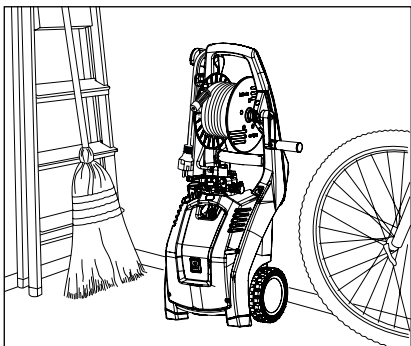

Due to their small base, the compact and mobile Kränzle high-pressure cleaners are easy to store.

Problem

No water from nozzle although the high-pressure cleaner is running.

Cause

Most likely the nozzle is blocked.

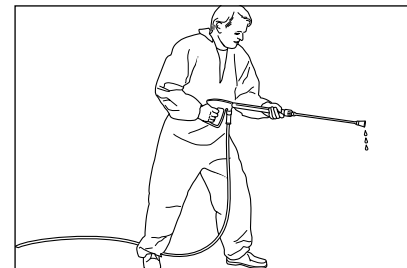

No or very little water from the lance.

Proceeding:

Switch off the high-pressure cleaner. Pull plug from the socket. Operate safety trigger gun catch several times to decrease the pressure.

Unscrew safety trigger gun and lance first, then rinse high-pressure hose to remove possible soiling.

Check water inlet filter for soiling.

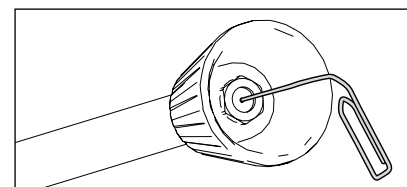

If the problem still exists, take wire (paper clip) and push through nozzle opening. If this procedure is not successful, the nozzle has to be replaced.



Pull plug from socket prior to starting any repair work!

Problem

Irregular jet from nozzle.

Cause

Most likely the valves are soiled or sticky.

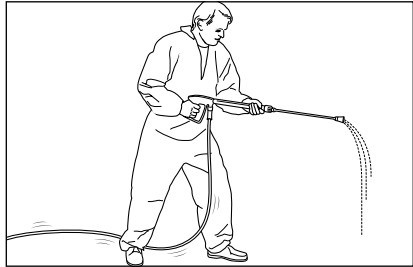

The water from the lance comes in squirts. The high-pressure hose vibrates.

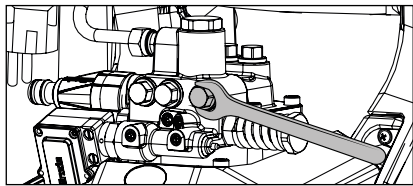

Proceeding:

Unscrew all 6 valves, one after the other (hexagonal brass screws, 3 in a row, vertically and horizontally)

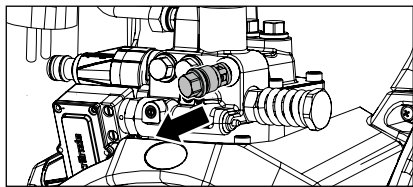

Take out valve body and O-ring by means of needle nose pliers. Check O-ring for damage. In case of a damage the O-ring has to be replaced.

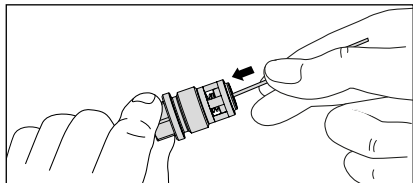

Take a wire (paper clip) and clean valves under running water.

Do not forget the O-ring during reassembly!

Problem

After closing the safety trigger gun the high-pressure cleaner keeps switching on and off.

Possible cause No. 1

Leakage.

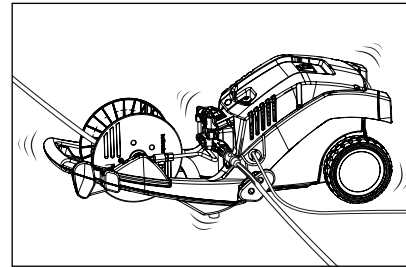

Having closed the safety trigger gun, the high-pressure cleaner must shut down. Failure to shut down may be caused by leakage in the high-pressure pump, the switch, the high-pressure hose, the safety trigger gun or the lance.

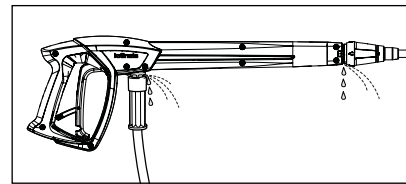

Proceeding:

Check connections from the high-pressure cleaner to the high-pressure hose and from the high-pressure hose to the safety trigger gun and also the connection between lance and safety trigger gun for tightness.

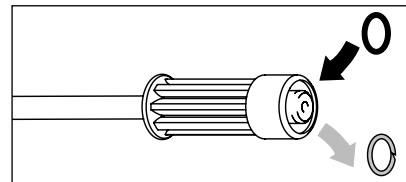

Switch off the cleaner. Shortly press the trigger of the trigger gun with safety catch to decrease the pressure. Remove high-pressure hose, trigger gun with safety catch and lance and check the O-rings. If the O-rings are damaged they have to be replaced.



In case of a leakage there is no guarantee for possible consequential damages.

Problem

After closing the safety trigger gun the high-pressure cleaner keeps switching on and off.

Possible cause No. 2

The non-return valve is defective.

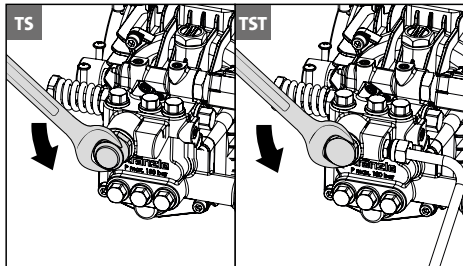

Proceeding:

Switch off the high-pressure cleaner and pull plug from socket. Stop water supply. Operate safety trigger gun catch several times to decrease the pressure. Unscrew pump outlet.

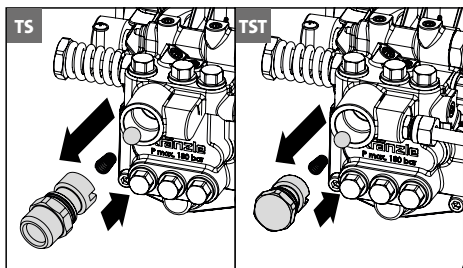

Remove check body and check O-Ring for soiling or damage. Also check seal seat inside pump housing for soiling or damage.

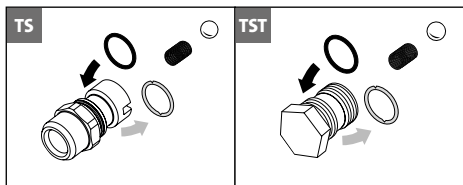

If sealing rings are defective replace O-rings at once.



There is no guarantee if the high-pressure pump is damaged by defective O-rings due to air induction or lack of water (cavitation).

We here by declare that the design of the high-pressure cleaners: **K 1050 TS**
K 1050 TST

Nominal flow: **450 l/h**

technical specifications available from: **Josef Kränzle GmbH & Co. KG**
Manfred Bauer
Rudolf-Diesel-Str. 20, 89257 Illertissen

comply with the following guidelines and their amendments for high-pressure cleaners: **Machinery Directive 2006/42/EC**
EMC Directive 2014/30/EU
ROHS Directive 2011/65/EU
Outdoor Directive 2000/14/EC

Noise pressure level, typical: **91.9 dB (A)**
Noise pressure level, guaranteed: **93 dB (A)**

Applied conformity assessment procedure: **Annex V, Outdoor Directive 2000/14/EC**

Applied specifications and standards: **EN 60335-1:2012/A13:2017**
EN 60335-2-79:2012
EN 62233: 2008
EN 55014-1: 2006+A1: 2009+A2: 2011
EN 55014-2: 2015
EN 61000-3-2: 2014
EN 61000-3-3: 2013

Josef Kränzle GmbH & Co. KG
Rudolf-Diesel-Straße 20
89257 Illertissen (Germany)

Ludwig Kränzle
(Managing director)

Illertissen, 2019-04-05

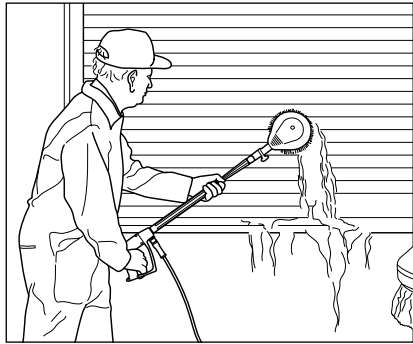

**Rotating washing brush
BRUSH light**

- 210 mm
- Stainless steel extension
- Brush head Ø 180 mm
- Nozzle size 2.5 mm

Item no.: 12800

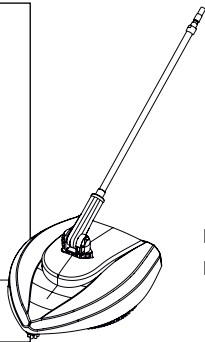

**Floor washer
Round Cleaner UFO light**

- Ø 260 mm
- Nozzle system 03

Item no.: 41870

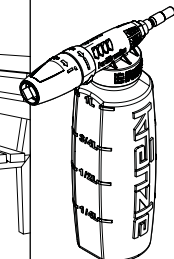
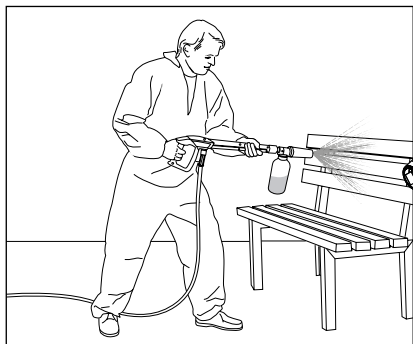

Foam injector light

- With container
- Nozzle system 03

1 litre Item no.: 135302
2 litre Item no.: 135312

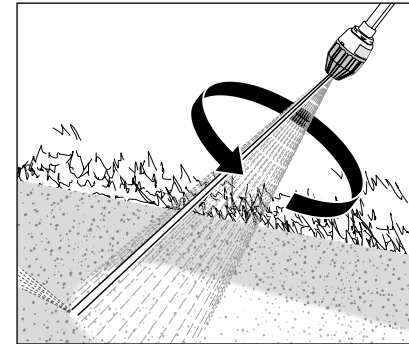

Filth killer lance light

- 400 mm
- Nozzle system 03

Item no.: 42403-03

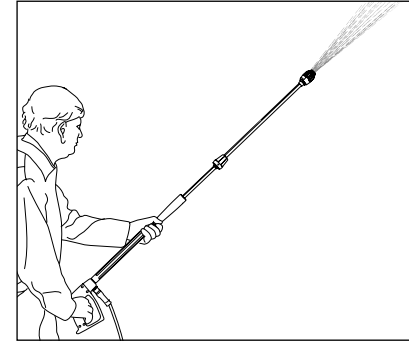

Lance extension light

- 400 mm

Item no.: 12870

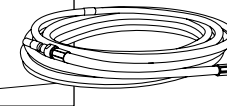
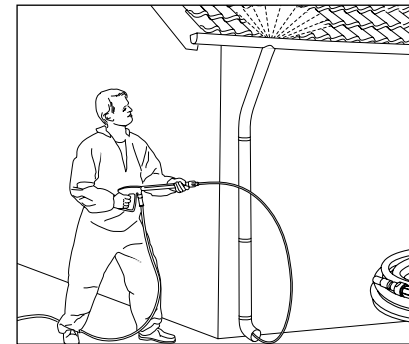

Pipe cleaning hose light

- 10 m length
- Nozzle system 03

Item no.: 12850



The high-pressure cleaner accessories are safety components!
Any warranty will be void if parts not authorised by Kränzle are used.



Please indicate the technical data of the high-pressure cleaner (device type) when placing your order.

This Kränzle high-pressure cleaner is solely designed for home users for typical applications around the house and garden (for cleaning façades, patios, garden equipment, tools, vehicles and machinery as well as building structures). It is not intended for commercial use.

The warranty obligation of Josef Kränzle GmbH & Co. KG towards the dealer from whom you have purchased this Kränzle-high-pressure cleaner (= product) applies to material faults only such as material and manufacturing defects.

Defects attributable to long and frequent use of the product, typically arising due to the age of the high-pressure cleaner and intensity of its use are defined as normal wear in respect of product components. Purchaser's rights to assert claims for such defects are ruled out. Parts subject to wear include in particular the pressure gauge, nozzle, valves, sleeves, high-pressure hose and spray equipment.

The product is to be operated in conformity with this operating manual. The operating manual is deemed to be part of the warranty provisions.

Any changes made to the safety devices of the product or instances of maloperation – such as exceeding the temperature and speed limits, undervoltage, insufficient water supply and sewage water, or failure to use the product for the intended purpose – may result in damage occurring to the product. Such damage is not deemed to constitute any material defect.

Should the use of accessories or spares other than original Kränzle component parts and original Kränzle replacement parts be the cause of defects on our product, this may lead to all warranty claims becoming null and void. Only the use of original Kränzle replacement parts matching the relevant Kränzle high-pressure cleaner provides adequate assurance for safe and trouble-free operation of the Kränzle high-pressure cleaner.

With regard to legal warranty claims, the limitation periods of the respective countries shall apply.

Where warranty claims apply to any other defects, please contact your local dealer, presenting the accessories together with your purchase receipt, or the nearest authorised service centre. This can also be found on the internet under **www.kraenzle.com**.

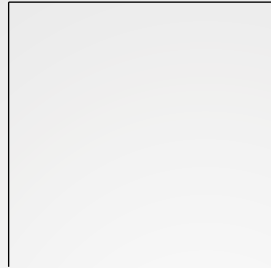

Josef Kränzle GmbH & Co. KG

Rudolf-Diesel-Straße 20
89257 Illertissen (Germany)

sales@kraenzle.com

© Kranzle 25.02.2021 / Ord. no.: 306140 / Subject to technical modifications and errors.

■ **Made**
■ **in**
■ **Germany**